

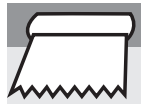

Ambient temperature  
Min: 10° C



Substrate temperature  
Min: 10° C

Before laying the flooring, it is a good idea to inspect it and to identify any problems with the appearance.  
If there are visible defects, please notify GERFLOR and wait to hear from them before laying the flooring.

## DISSIPATIVE FLOORING (DIF)

Laying with conductive pre-coating, conductive adhesive, + copper strip: code 0586 (length: 200 m)  
Before laying, store the adhesive and rolls (unrolled and laid flat) for 24 hours in the room where they are to be fitted.

## TABLE OF RECOMMENDED ADHESIVES AND PRIMERS

### Specifications for dissipative floorings:

- The electrical resistance of the flooring is between 106 and 108 ohms for dissipative flooring according to standard NF EN 13 415-NF EN 1081 (tripod method) or standard NF EN 61-340-4-1 (electrode method) or ASTM F 150 NF PA 99 [surface resistivity ESD S.1 and volume resistivity ESD S 7) or IEC 1340-4-1 (CNET Electrode).

### Specifications for dissipative flooring after laying (glue-down product)

- The regulations requires a value of electrical resistance to earth between 10<sup>7</sup> and 10<sup>9</sup> ohms to take into account losses due to laying.

MANUFACTURER	CONDUCTIVE PRIMER	CONDUCTIVE ADHESIVE	SPATULA
BOSTIK	Consult the manufacturer	Consult the manufacturer	Sharp-toothed
UZIN	Consult the manufacturer	Consult the manufacturer	
EUROCOL	041 PRIMER NEODIS EL	523 EL HELMIDAL PLUS EL	
CEGECOL	Consult the manufacturer	Consult the manufacturer	
MAPEI	Conductive PRIMER G	Conductive ADESILEX V 4	

The information given in this table is valid as on 01/04/2014 and is subject to change based on the information provided by manufacturers

- CAUTION:**
- Carefully follow the adhesive supplier's instructions and observe the drying time.
  - Insufficient drying time leads to blistering.
  - Excessive drying time leads to: Poor coating of the adhesive onto the material.  
: Poor adherence of the material  
: Blistering when stress is applied
  - Do not overlap two adhesive films when you apply more adhesive.

## 1. CHOICE OF JOINT TREATMENT

This material can only be heat-welded (at least 24 hours after gluing)

### IMPORTANT

Joint treatment method for class E rooms:

CLASSIFICATION		PRODUCT
Pitting resistance		P3 at least
Finish	E2*	Joints heat-welded + caulked at the edges (leave a 3 mm gap to apply mastic)
	E3	Heat-welded joints + skirting according to the contractor's requirement.

See the section on FINISHES - "Joint treatments". \* Skirting must be installed after the flooring is laid.

## 2. LAYING

### Preparation

Because this flooring has specific electrical characteristics, it should be laid using the following method.

#### ■ 2.1 - APPLYING THE CONDUCTIVE PRE-COATING

- Mix thoroughly before each application. Use a foam roller to apply a thin, even layer of a conductive primer with a coverage of about 100 to 150 gr/m<sup>2</sup>.
- Leave to dry according to the adhesive manufacturer's instructions.

#### ■ 2.2 - EARTHING THE STRIP

- Mark the arrangement of the strip, in consultation with the electric power company.

- Room  $\leq 40$  m<sup>2</sup>:

a copper strip around the edge of the room, placed 15 cm from the walls, diagonally. This strip should be earthed at both ends.

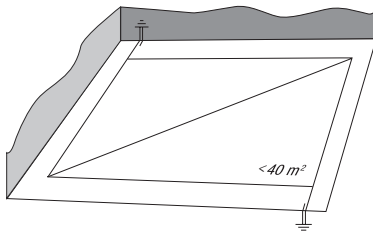

- For a larger room  $> 40$  m<sup>2</sup>:

a copper strip around the edge and along the longer diagonal of the room is necessary. This strip must be earthed every 40 m<sup>2</sup> of flooring (see diagram).

- Apply adhesive to the substrate on the width of the strip using conductive adhesive (with the same adhesive as the one used for gluing the flooring). Apply the copper strip on the applied adhesive.
- After smoothing the copper strip, remove the excess adhesive on either side of the strip.
- The copper strip can be located later by telegraphing.

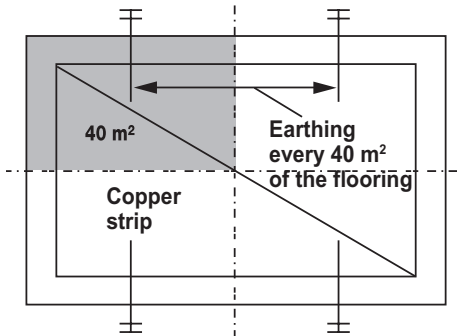

#### ■ 2.3 - LAYING THE TILES

The tiles must be taken out of their boxes at least 24 hours before they are laid.

#### IMPORTANT:

- Laying direction: 90° or in the same direction.
- Heat welding: tight joint laying without forcing so that the guide of the chamfering machine can be inserted.

#### ■ 2.4 - APPLYING ADHESIVE TO THE SUBSTRATE AND LAYING THE TILES

- The flooring is laid in a single spread using conductive adhesive.
- Lay the tiles in staircase pattern along the lines on the substrate.
- Make sure the tiles are grouted properly.

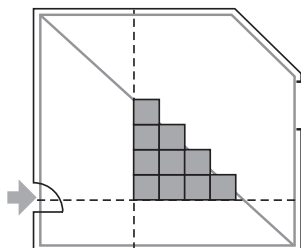

- The adhesive may be applied to the strip.
- Coverage: depending on the type and composition of the adhesive (about 250 to 300 gr/m<sup>2</sup>). The spatula will need to be changed regularly to maintain this coverage.
- Take care not to cut/damage the strip while applying the adhesive.
- Do not overlap two adhesive films when you apply more adhesive.
- As you work, remove any fresh adhesive left behind.

#### ■ 2.5 - SMOOTHING

Smoothing must be done in two passes:

- Manually using a smoothing block.
- Careful smoothing over the entire surface using a smoothing roller (heavy), to flatten the lines of adhesive and to ensure that the adhesive coats the back of the flooring properly. This is done as the flooring is laid, and again after work is finished.

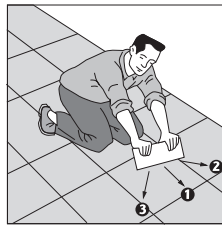

1st pass: manual smoothing

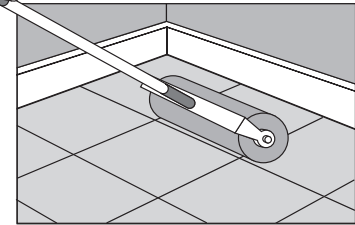

2nd pass: smoothing with a roller

#### ■ 2.6 - CAULKING

Installed according to classification: E2

Installed according to classification: E3

See the section on "FINISHES - Skirting".

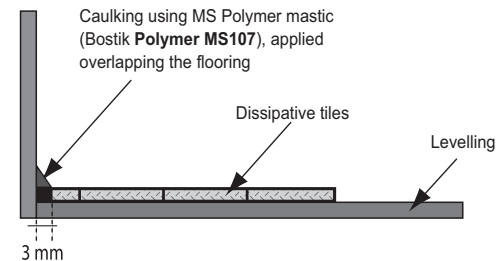

#### ■ 2.7 - JOINT TREATMENT

See the section on "FINISHES - Joint treatments". Heat welding of flooring in tiles.

#### ■ 2.8 - TIME BEFORE FIRST USE

- For normal foot traffic, the floor can be used 48 hours after completion of work.
- For installing furniture or moving loads on wheels, wait 72 hours after completing the work.
- Do not use rubber feet on furniture.
- Underfloor heating should be switched on 7 days after the flooring is laid.